



S D 14

MONOBLOCK
DIRECTIONAL CONTROL VALVES



SD14

Features

Simple, compact designed, this valves is only one section for open centre and closed centre hydraulic systems.

H Fitted with a main pressure relief valve.

H Diameter 20 mm - 0.79 in interchangeable spools.

H Available manual, pneumatic, electro-hydraulic and remote with flexible cable spool control kits.

Working conditions

This catalogue shows technical specifications and diagrams measured with mineral oil of 46 mm²/s - 46 cSt viscosity at 40°C temperature.

Nominal flow rating		120 l/min	
Operating pressure (maximum)		250 bar	3600 psi
Back pressure (maximum)	on outlet port T	25 bar	360 psi
Internal leakage A(B)→T	$\Delta p = 100 \text{ bar} - 1450 \text{ psi}$ fluid and valve at 40°C - 104°F	3 cm ³ /min	0.18 in ³ /min
Fluid		Mineral base oil	
Fluid temperature	with NBR (BUNA-N) seals	from -20° to 80°C	
	with FPM (VITON) seals	from -20° to 100°C	
Viscosity	operating range	from 15 to 75 mm ² /s	from 15 to 75 cSt
	min	12 mm ² /s	12 cSt
	max	400 mm ² /s	400 cSt
Max level of contamination		19/16 - ISO 4406	
Ambient temperature		from -40° to 60°C	

NOTE - For different conditions please contact Customer Service.

Additional information

This catalogue shows the product in the most usual configurations.

Please contact Customer Service Dpt. for more detailed information or special request.

WARNING!

All specifications of this catalogue refers to the standard product at this date. Walvoil, oriented to a continuous improvement, reserves the right to discontinue, modify or revise the specifications, without notice.

WALVOIL IS NOT RESPONSIBLE FOR ANY DAMAGE CAUSED BY AN INCORRECT USE OF THE PRODUCT.

7th edition October 2000:

This edition supercedes all prior documents.

Dimensional data

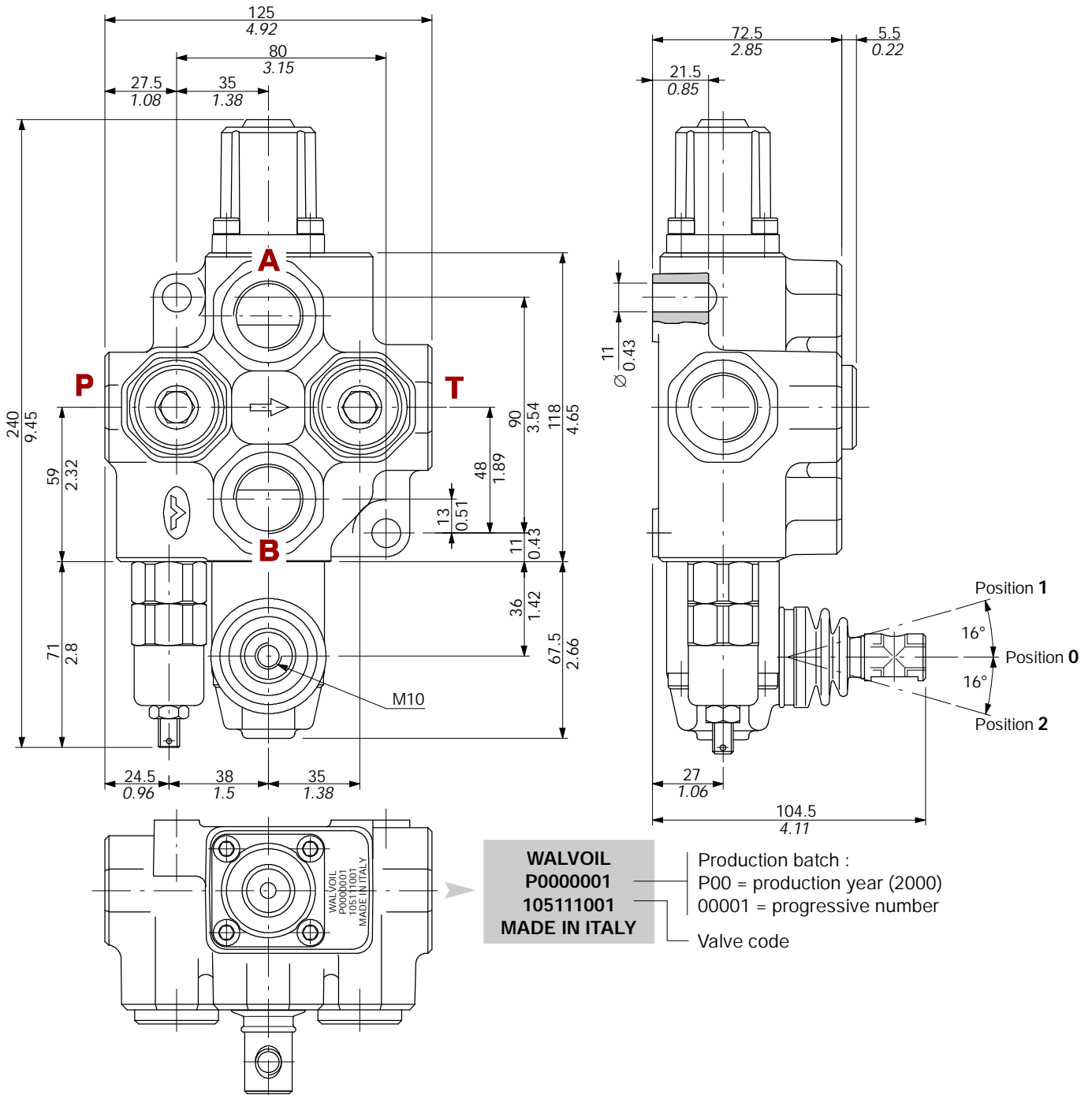

Standard threads

PORT	BSP (ISO 228/1)	UN-UNF (ISO 11926-1)
Inlet P		
A and B ports	G 3/4	1 1/16-12 UN-2B (SAE 12)
Outlet T		
PILOT PORTS		
Pneumatic	NPTF 1/8-27	NPTF 1/8-27

SD14

Hydraulic circuit

Standard valve is supplied with positive overlap spool (1CP).

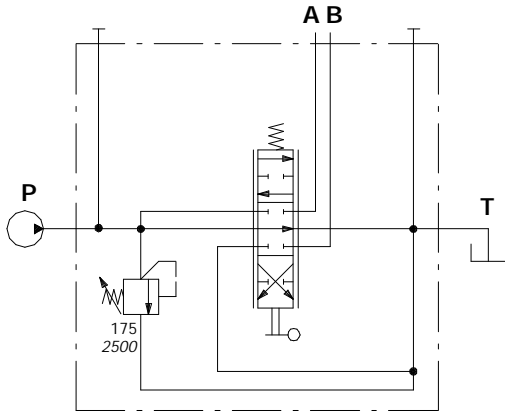

Ex.: SD14/1(YG3-175)/1CP8L

Right inlet

A symmetrical body allows the reverse assembly of spool and relative control kit and lever (ED configuration).

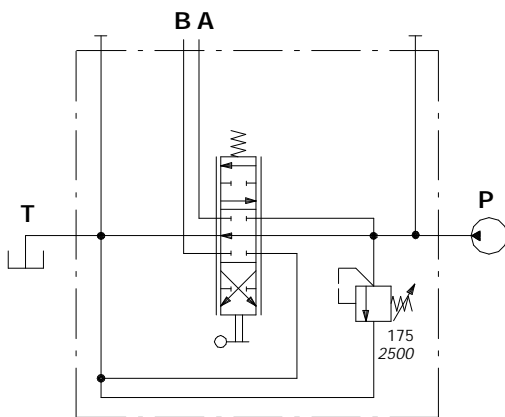

Ex.: SD14/1(YG3-175)/ED-1CP8L

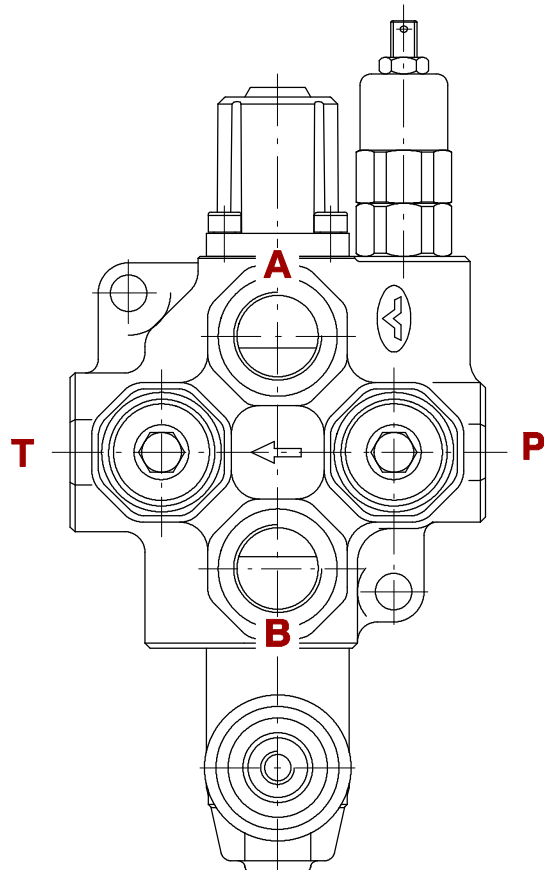

Performance data (pressure drop vs. flow)

Open centre

From inlet to outlet.

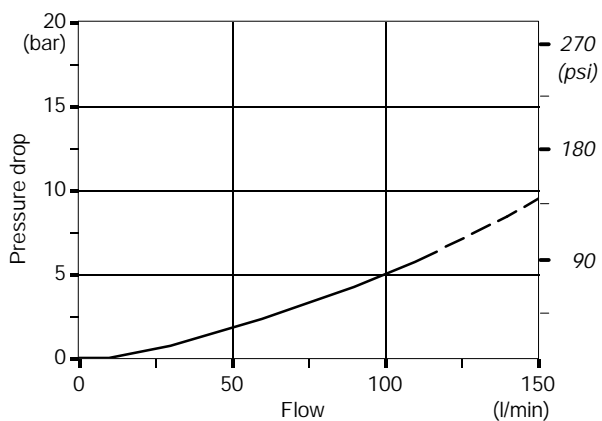
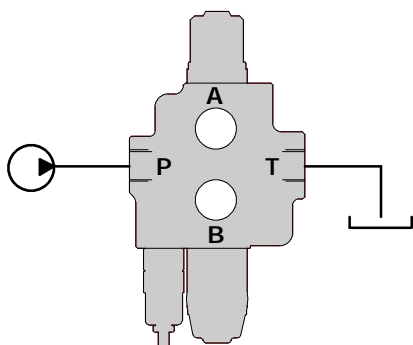

Inlet to work port

From inlet to A port (spool in position 1) or B port (spool in position 2).

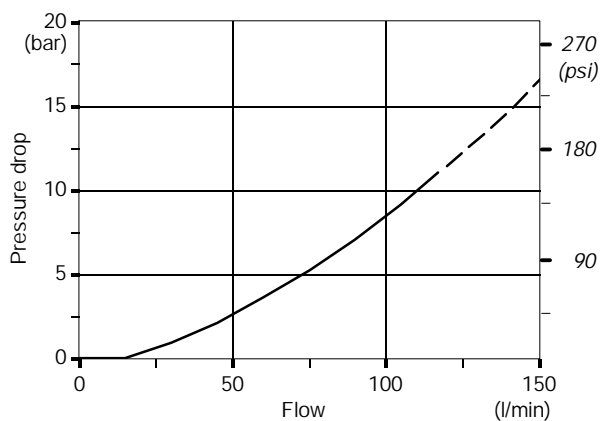
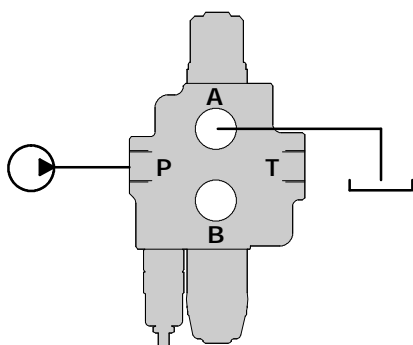

Work port to outlet

From A port (spool in position 2) or B port (spool in position 1) to outlet.

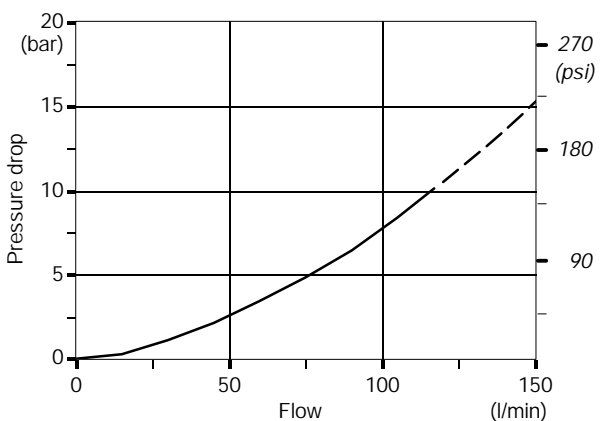
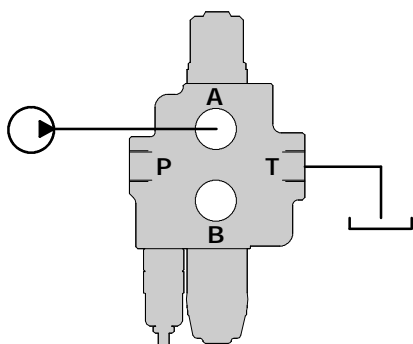

NOTE - Measured with spool type 1CP.

SD14

Ordering codes

Description example:

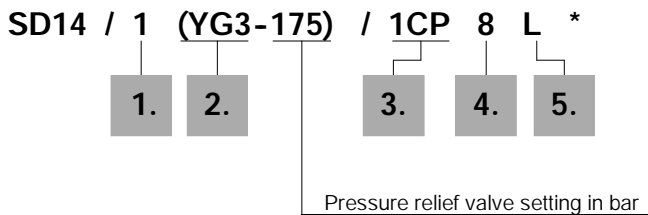

1. Body kits *

TYPE	CODE	DESCRIPTION
1	5KC1603040	1 section

Include boby, seals and rings.

2. Inlet relief options

TYPE	CODE	DESCRIPTION
<u>VMD10/1 direct pressure relief valve type Y</u>		
(YG2-125)	3XCAR110212	Range 80 to 160 bar / 1150 to 2300 psi standard setting 125 bar / 1800 psi
(YG3-175)	3XCAR110213	Range 125 to 250 bar / 1800 to 3600 psi standard setting 175 bar / 2500 psi
(YG4-220)	3XCAR110214	Range 200 to 315 bar / 2900 to 4600 psi standard setting 220 bar / 3200 psi
<u>VMP10/1 pilot operated pressure relief valve type X</u>		
(XG-125)	X006211120	Range 25 to 315 bar / 360 to 4600 psi standard setting 125 bar / 1800 psi

Standard setting is referred to 10 l/min flow.

SV	XTAP526340	Relief valve blanking plug
----	------------	----------------------------

3. Spool options

TYPE	CODE	CIRCUIT DESCRIPTION
1CP	3CU1510140	Double acting with positive overlap, 3 positions, A and B closed in neutral position
1N	3CU1510100	Double acting, 3 positions, A and B closed in neutral position
2	3CU1525600	Double acting, 3 positions, with A open to tank in neutral position
3CP	3CU1531140	Single acting on A, 3 positions, B plugged requires G3/4 plug (see part I)
4CP	3CU1535140	Single acting on B, 3 positions, A plugged requires G3/4 plug (see part I)
6	3CU1550100	Double acting, 3 positions, closed center
7	3CU1555100	Double acting, 3 positions, closed center with A and B to tank in neutral position

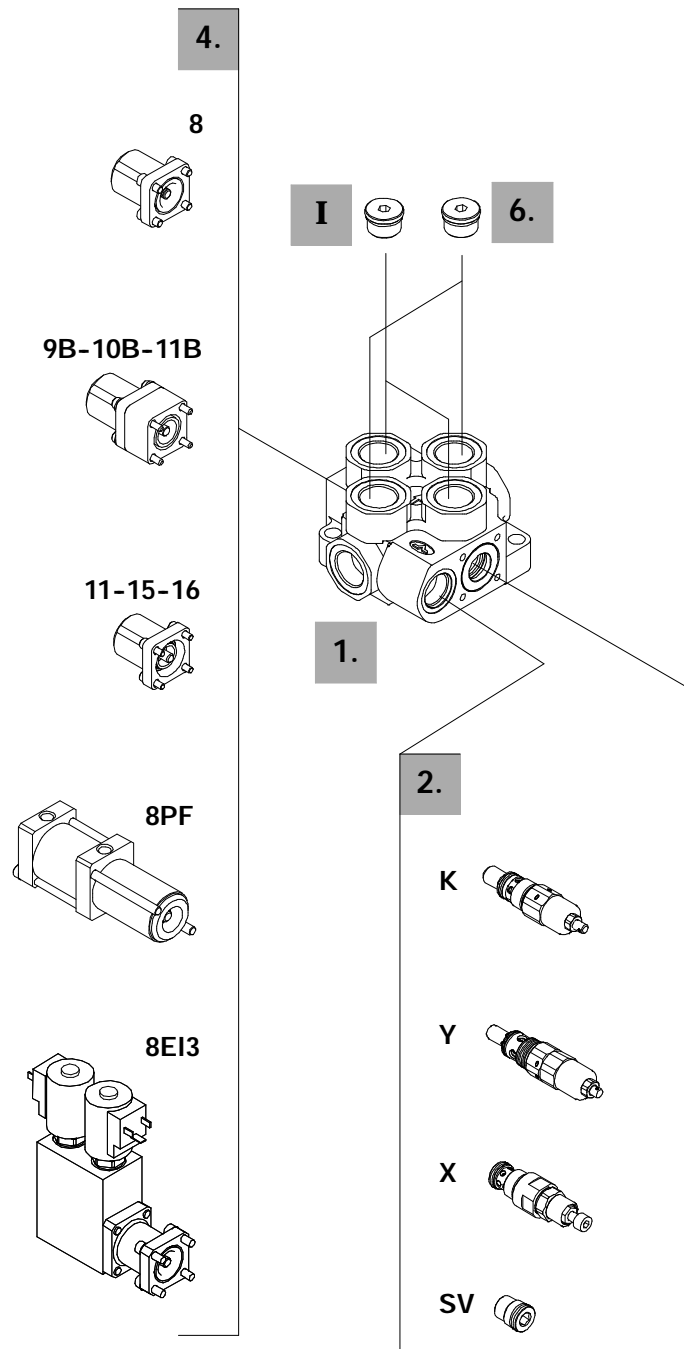

NOTE (*) - Items are referred to **BSP** thread.

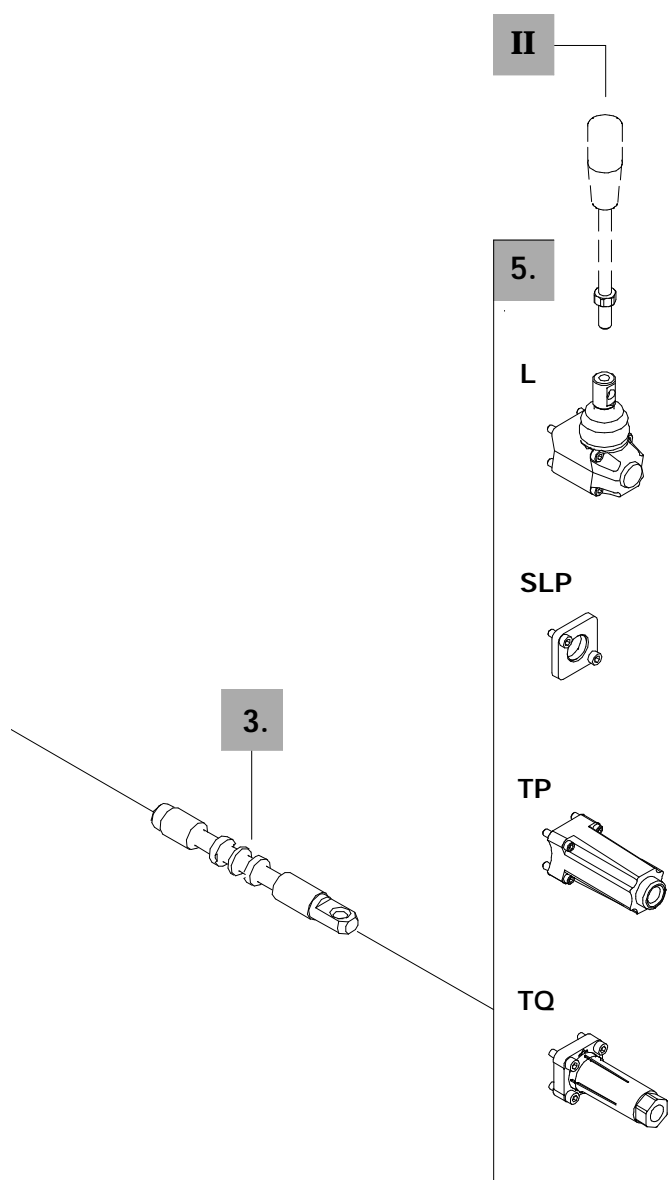

4. "A" side spool positioners

TYPE	CODE	DESCRIPTION
8	5V08110000	With spring return in neutral position
9B	5V09110000	With detent in position 1 and spring return in neutral position
10B	5V09110000	With detent in position 2 and spring return in neutral position
11	5V11110000	With detent in position 1, neutral and 2
11B	5V11210000	With detent in position 1 and 2, spring return in neutral position
15	5V15110000	With detent in position 1 and neutral
16	5V16110000	With detent in position 2 and neutral
8PF	5V08110705	Proportional pneumatic kit
8E13	5V08110350	12 VDC ON/OFF electro-hydraulic kit
	5V08110351	24 VDC ON/OFF electro-hydraulic kit

5. "B" side handle options

TYPE	CODE	DESCRIPTION
L	5LEV110000	Standard lever box
SLP	5COP110000	Without lever, with dust proof plate
TP	5TEL110005	CG cable connection
TQ	5TEL110110	CD cable connection

6. Inlet and outlet selection *

TYPE	CODE	DESCRIPTION
PSL	3XTAP732200	G3/4 plug for side inlet and outlet (nr.2 plugs required). Standard configuration; "PSL" must be omitted
PSA	3XTAP732200	G3/4 plug for upper inlet and outlet (nr.2 plug required)

I Port plug *

TYPE	CODE	DESCRIPTION
G3/4	3XTAP732200	Plug for single acting spool

II Optional handlelevers

TYPE	CODE	DESCRIPTION
AL01/M10x200	170012020	Lenght L = 200mm / 7.87in

For special configurations see pages 9 and 10

Spools options

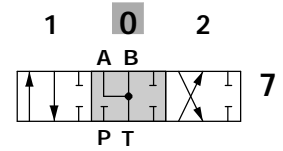
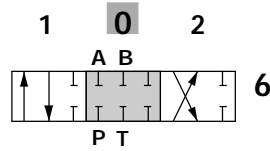
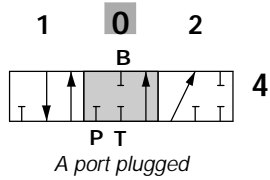
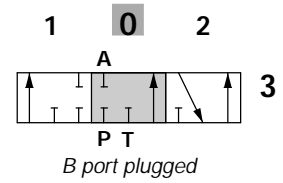
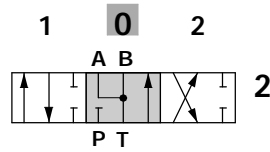
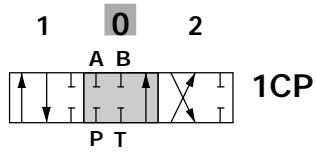

"A" side spool positioners

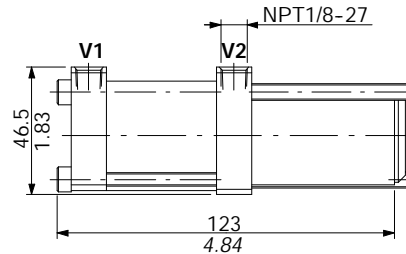
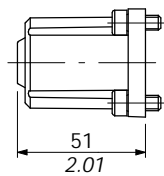

Operating features

Adjustment range : from 2 to 6.5 bar
(29 to 94 psi)
diagram 501A
Max.pilot pressure: 10 bar (145 psi)

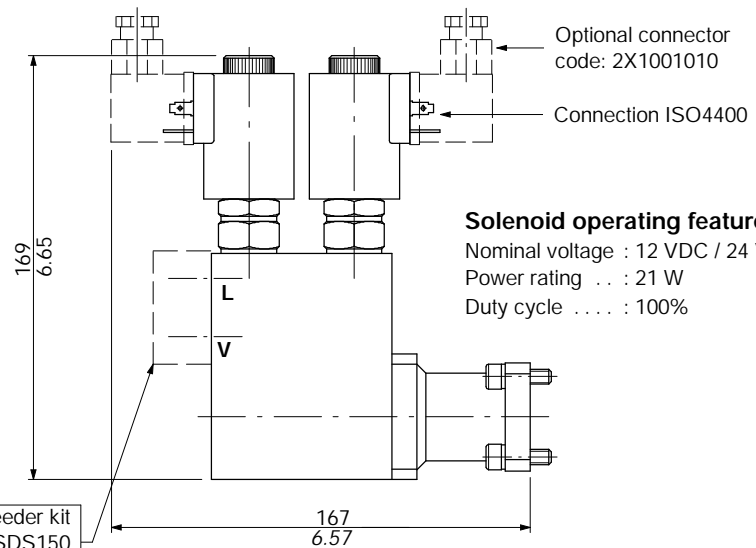
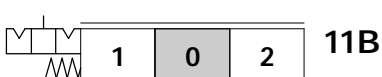
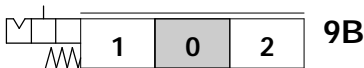
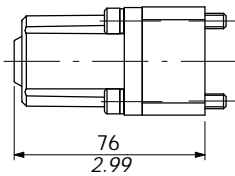
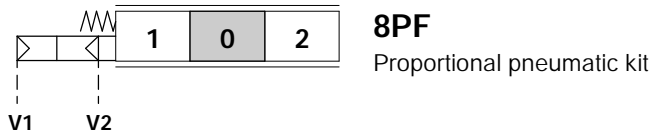
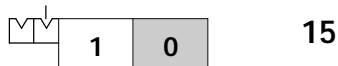
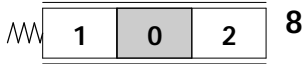

Solenoid operating features

Nominal voltage : 12 VDC / 24 VDC
Power rating ... : 21 W
Duty cycle : 100%

Feeder kit
(see catalogue SDS150
at page 13)

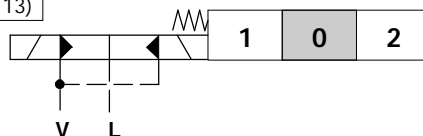

Directional valve with rotary control kit

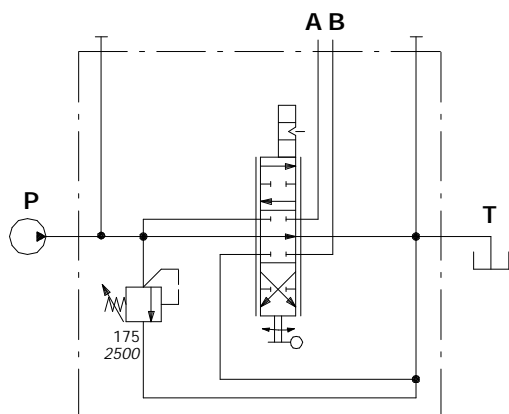
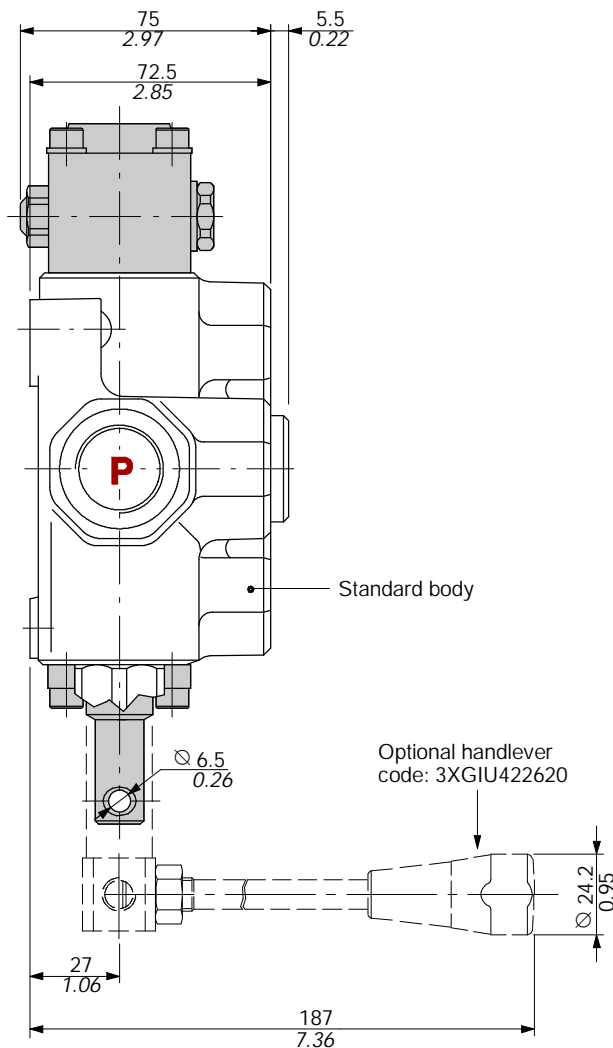
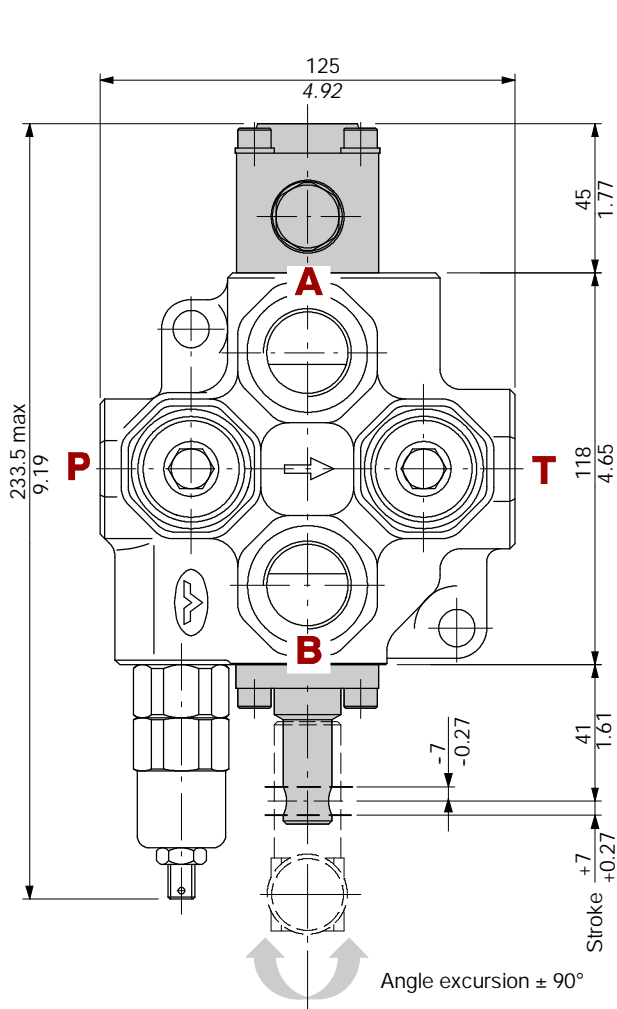

Ex.: SD14/1(YG3-175)/ 1N R SLP

- Dust proof plate kit: code 5COP110000
- Rotary positioner kit: code 5ROT110000
- Spool: code 3CU1510561 (egative overlap)

SD14

Special configurations

Spool in regenerative 4th position

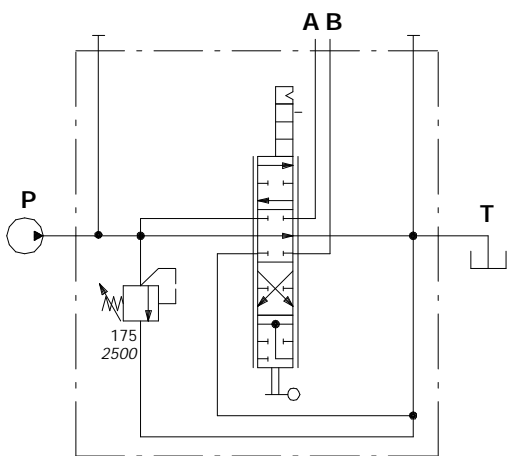
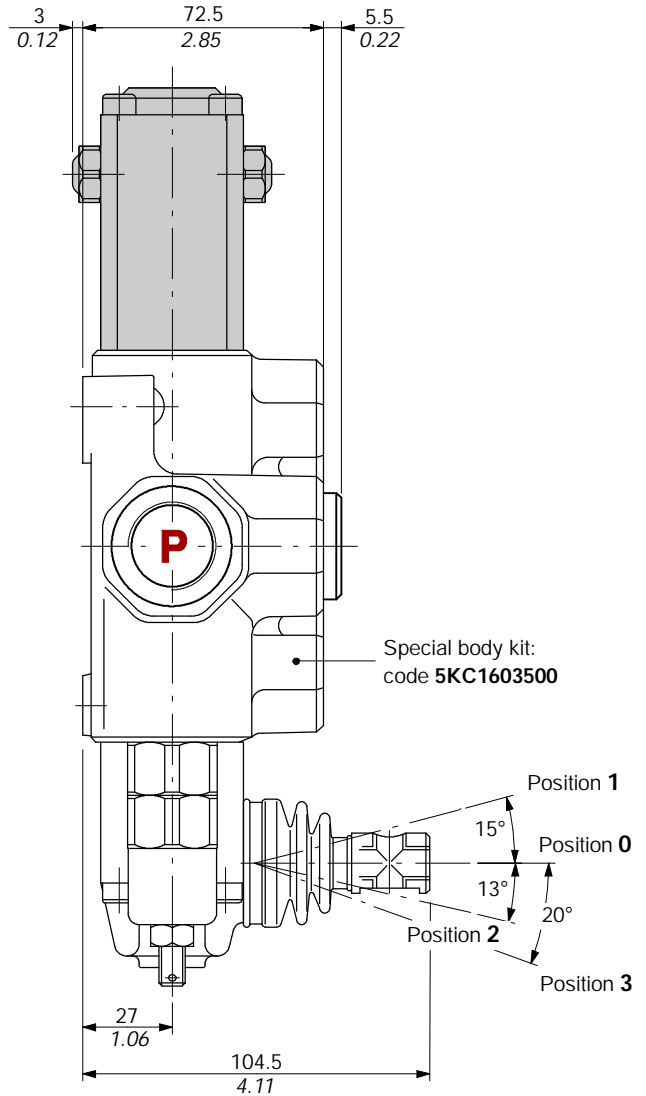
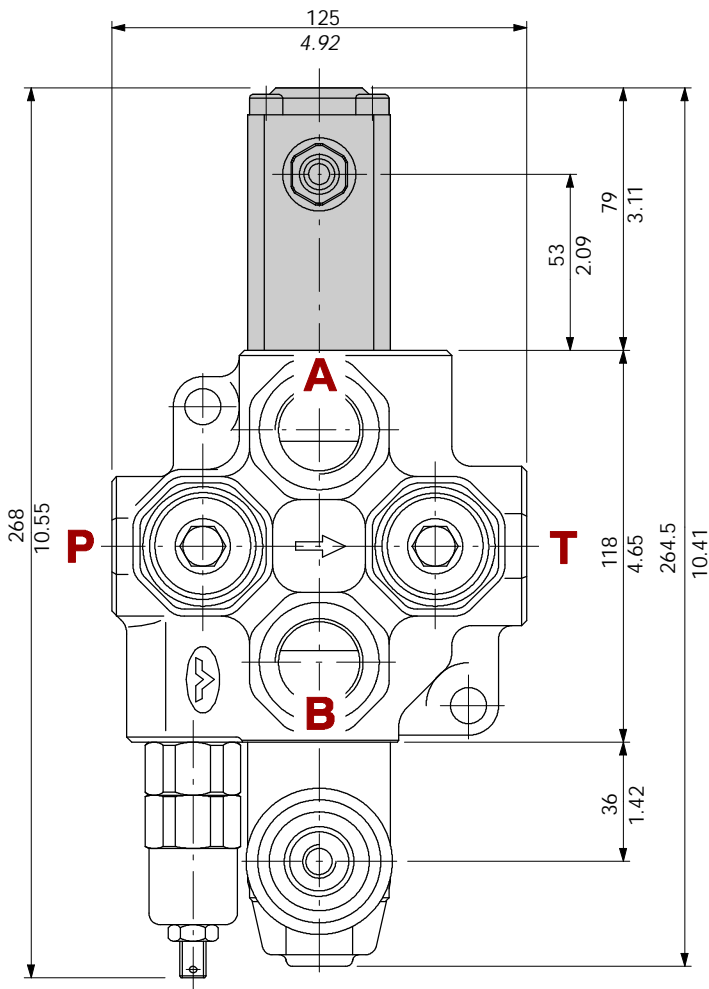

Ex.: SD14/1(YG3-175)/ 8 13F1 L

Positioner kit: code 5V13611000

Spool: code 3CU1562130

Installation and maintenance

The SD14 valve is assembled and tested as per the technical specification of this catalogue.

Before the final installation on your equipment, follow the below recommendations:

- the valve can be assembled in any position, in order to prevent body deformation and spool sticking mount the product on a flat surface;
- in order to prevent the possibility of water entering the lever box and spool control kit, do not use high pressure wash down directly on the valve;
- prior to painting, ensure plastic port plugs are tightly in place.

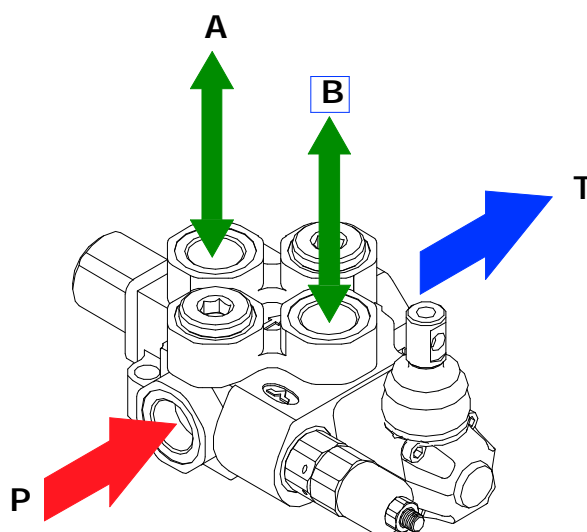

Fitting tightening torque - Nm / lbft

THREADS TYPE	All ports
BSP (ISO 228/1)	G 3/4
With O-Ring seal	90 / 66.4
With copper washer	60 / 44.3
With steel and rubber washer	70 / 51.6
UN-UNF (ISO 11926-1)	1 1/16-12 UN-2B (SAE 12)
With O-Ring seal	95 / 70

NOTE - These torque are recommended. Assembly tightening torque depends on many factors, including lubrication, coating and surface finish. The manufacturer shall be consulted.



WALVOIL S.P.A.

42100 REGGIO EMILIA • ITALY • VIA ADIGE, 13/D
TEL. +39.0522.932411 • FAX +39.0522.300984
E-MAIL: INFO@WALVOIL.COM • HTTP: //WWW.WALVOIL.COM

SALES DEPARTMENT

TEL. +39.0522.932555 • FAX +39.0522.932455

DAC005E